

Otello 8 HD VariWhite +

Last update:
29/03/2023



Otello 8 HD + with 8 leaf barndoor

Introducing

● Developed to offer the best solution in the stage lighting field focussing on **theatre and TV studios applications**, Otello Led Fresnel incorporates all traditional characteristics of a Fresnel light such as the **distinctive soft-edged** and **very wide beam** and the **smooth and homogeneous light field**.

The improved **HD electronic** with an advanced LED controller guarantees a smooth 20 bit dimming and a superlative **color mixing**.

Next to the traditional manual or P.O. option, Otello offers an optional motorized zoom, which together with a modern design and Oled display with on-board selector for quick setting represents the state of the art in terms of LED Fresnel range. The family consists of 2 fixtures with lenses of 150 mm (5,9 inch) and 200 mm (7,87 inch). All variants include COB, VariWhite, Studio and FullSpectrum 6 LEDs in 3 power steps.

● **FullSpectrum** : 2.700 – 20.000 K (CRI average > 95); Red, Green, Blue, Cyan, Lime, Amber color mixing with Green-Magenta adjustment

● **VariWhite | Tungsten | Daylight**: white engines with the Tungsten and Daylight COB LED calibrated respectively at 3.000 K and 5.600 K CCT and a tunable white source ranging from 2.800 to 6.500 K (CRI > 94) for the VariWhite version

Key Features



● VariWhite COB LED



● High CRI > 95



● CCT from 2.700 K → 6.500 K



● High Lumen flux and flat field



● Fresnel lens (diameter: 200 mm / 7.87 in)
 ● Zoom range from 8° to 48° half peak angle
 ● Available with Manual or Motorized Zoom



● Extruded aluminum, flame-retardant technopolymer reinforced with fiberglass



● Custom color on request (optional)



● Manual (standard) or Pole Operated Pan-Tilt (Optional)

General	
● LED Source	VariWhite COB LED
● CCT Range	●●●●● 2.700 K → 6.500 K
● Color Rendition Average	CRI> 95, TLCI> 95
● Dimming	8 or 16 bit, 5 selectable curves: Exponential, Logarithmic, Linear, Halo and Standard
● Dimming Smooth Selection	Fast, Slow and Very Slow
● Strobe	Electronic strobe, synchronized, random, pulse effect
● Lens	Glass Fresnel lens (diameter: 200 mm / 7.87 in)
● Optical	Zoom range from 8° to 48° half peak angle (motorized, manual or PO zoom available)
● Camera flicker control/Hz range	Yes: 20.000Hz
● Calibrated Cob	Yes
● L80 Rating (hours to 80% output)	50.000 Hours
Electrical	
● Voltage Input	80-264 V, 50/60 Hz, auto-sensing
● Power Consumption	340 W Maximum - 1.52 A at 230V, 3.05 A at 115V - cosφ: 0.94 (manual / P.O. zoom) 330 W Maximum - 1.61 A at 230V, 3.23 A at 115V - cosφ: 0.94 (motorized zoom)
● Power Connection	In and Out PowerCON TRUE1 Top connectors to feed up to 8 (at 230V) or 4 (at 115 V) fixtures
● Data Connection	In and Out DMX 5 pin locking XLR connectors
Thermal	
● Ambient Operating Temperature	0°C - +40°C (32°F - 104°F)
● Fan (controllable)	Yes, 4 different settings: Silent, Studio, Auto, DMX Regulated
Control	
● Protocols	DMX512A, RDM (Remote Device Management), Wireless (optional By LumenRadio)
● RDM configuration	Yes
● DMX Channels	Manual / PO zoom version: 5 / 2 / 1 Motorized zoom version: 6 / 4
● Display	Graphic OLED with on-board selector for quick setting
● Firmware upgrade	Through DMX with RDM Upgrade USB interface (code AC10011A001)
Physical	
● Yoke	Manual (standard) or Pole Operated Pan-Tilt (optional)
● Materials	Extruded aluminum, flame-retardant technopolymer reinforced with fiberglass
● Weight	With Manual Yoke: 13.5 Kg / 29.76 lbs - With Pole Operated Yoke: 15 Kg / 33.07 lbs
● Length	409 mm / 16.10 in
● Height	315 mm / 12.40 in
● Height with Yoke	With Manual Yoke: 437 mm / 17.20 in - With Pole Operated Yoke: 623 mm / 24.53 in
● Width	With Manual Yoke: 317 mm / 12.48 in - With Pole Operated Yoke: 406 mm / 15.99 in
● IP Rating	IP20
● Color options	Black (standard), custom color on request (optional)
Included accessories	
BC10044A002	8-Leaf Barndoor
GKIT17 (USA) / GKIT16 (EU)	1.5 m power cable with PowerCON TRUE1 Top and bare ends
BC10044A006	Color frame holder



Otello 8 HD + (manual zoom)
Rear Panel with the new OLED display



Otello 8 HD + with
Pole Operated Yoke and Pole Operated Zoom

Otello 8 HD+ PO version / Rear Panel

DMX Charts - Manual Zoom

5 Channels	2 Channels
01 → Master Dimmer	01 → Master Dimmer
02 → Dimmer Fine	02 → White Tone
03 → White tone	
04 → Strobe Effect	1 Channel
05 → Special Functions	01 → Master Dimmer - Color Temperature Settable by Display

DMX Charts - Motorized Zoom

6 Channels	4 Channels
01 → Master Dimmer	01 → Master Dimmer
02 → Dimmer Fine	02 → White Tone
03 → White tone	03 → Special Functions
04 → Strobe Effect	04 → Zoom
05 → Special Functions	
06 → Zoom	

Drawing Size - Manual Yoke Version

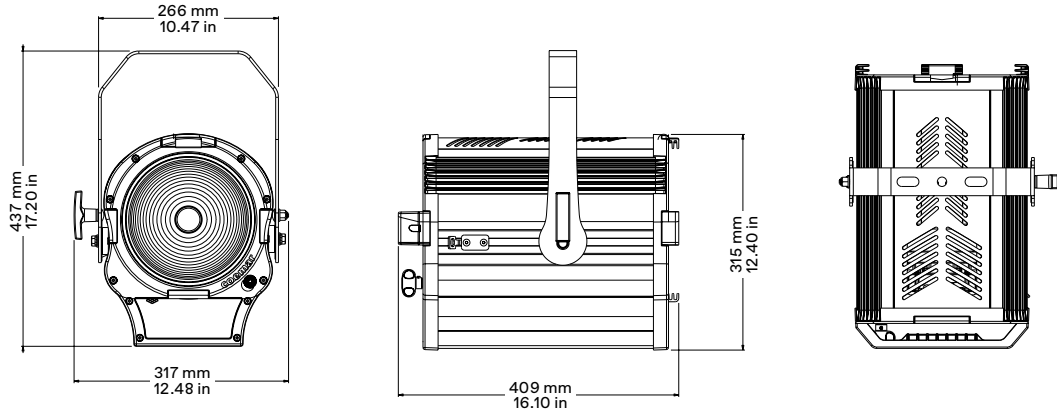

Drawing Size - Pole operated Yoke Version

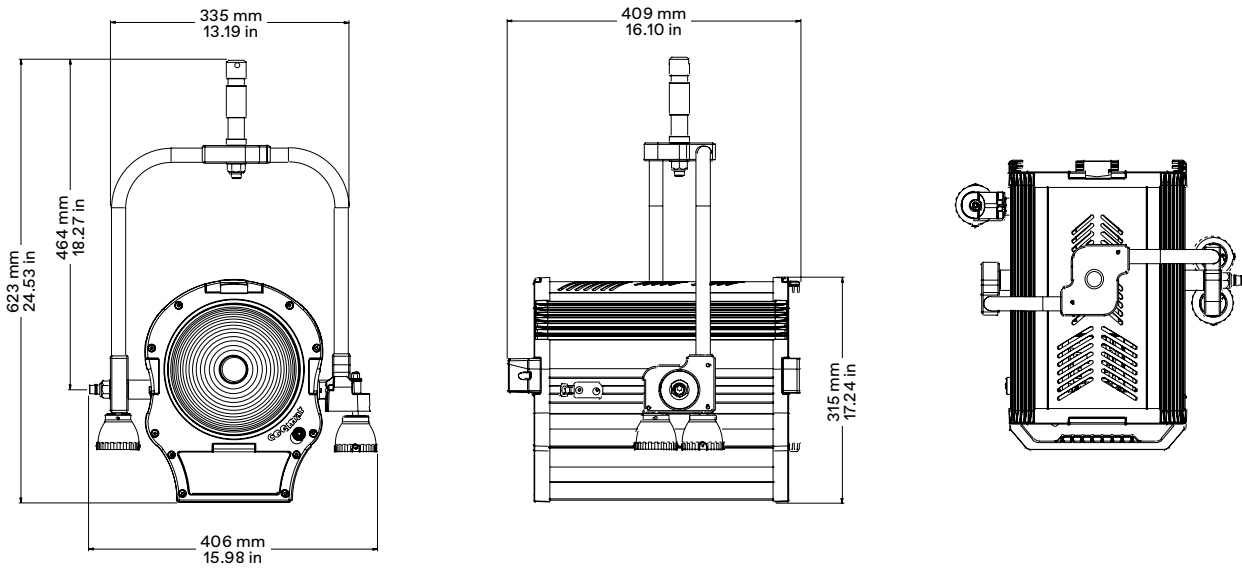

Models

Product	Code
Otello 8 VariWhite + Manual Yoke, Manual Zoom	F150G090Q
Otello 8 VariWhite + Manual Yoke, Motorized Zoom	F150G000Q
Otello 8 VariWhite + Pole Operated	F150G010Q

● Coemar Lighting S.r.l.

Via Carpenedolo, 90
46043, Castiglione delle Stiviere (MN) – Italy

P. +39 0376 1514412

M1. info@coemar.com

M2. service@coemar.com

W. coemar.com

P.iva – C.f. 02415330204

